

iNMOTION

RS

Electric Scooter User Manual



Before using your scooter, please read the instructions, and keep this manual for ready reference.
Original instructions



***i*NMOTION**
Climb Hills with Ease

GETTING STARTED

Thank you for choosing the INMOTION electric scooter(hereinafter referred to as the scooter)! This scooter is an intelligent high-tech entertainment product. When you use the scooter, there may be situations such as falling or collision that can cause injury and other risks. To reduce possible risks and ensure the personal and property safety of yourself and others, you have the responsibility and obligation to carefully read the user manual, fully understand all the warnings and precautions listed in this manual, and ensure that you can use it correctly. To obtain the latest feature/function information and safety guidance, please download the electronic version from the official website. Important! Read carefully and keep for future reference.

Serial number (referred to as SN below) is a unique identifier for each product, which can be used for product warranty, maintenance, insurance claims, loss confirmation, and so on. The SN is a 16-character numeric code that can be found on the packaging box label, the body of the product, or in the device information section of the associated App.

Get closer to your seller so he can refer you to an Appropriate training organization.

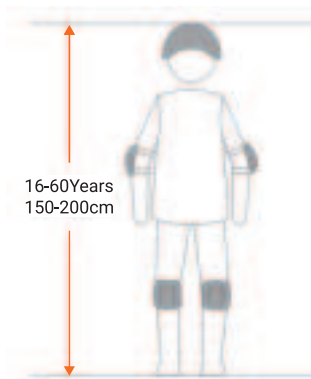

When riding an electric scooter, please wear a helmet, knee pads, elbow pads, wrist guards and other protective gear throughout the journey to reduce the risk of injury.

All pictures in this manual are for reference only. Please refer to the actual product for accuracy.

PRODUCT LIST

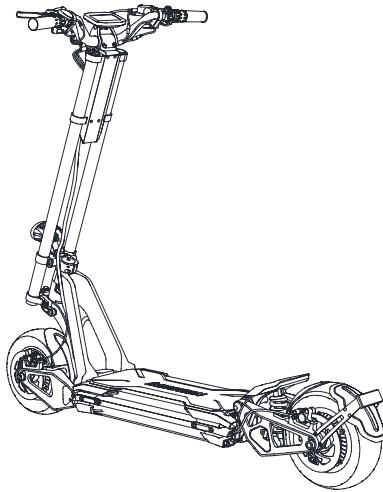

User Manual



Quick Start Guide

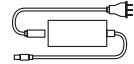

Power Cord/Adapter



Headlights



Mudguard Components



Reflectors * 2



Reflector Stickers * 10



Combination Wrench



T-shaped Wrench M5 * 2



M5x30 Hexagonal Cylindrical Head Screws * 4



M4x8 round head hexagon socket screw * 1



M4x10 Hexagonal Cylindrical Head Screws * 4



M8x16 Hexagon Socket Head Cap Screw * 1

Notice:

- Please carefully check whether the items in the packaging box are complete and intact. If any parts are missing or damaged, please contact your purchase point or send an email to the manufacturer.
- Please keep the box and packaging materials for at least 30 days in case you need to ship the scooter in the future.

PRODUCT FUNCTION INTRODUCTION

Product Diagram

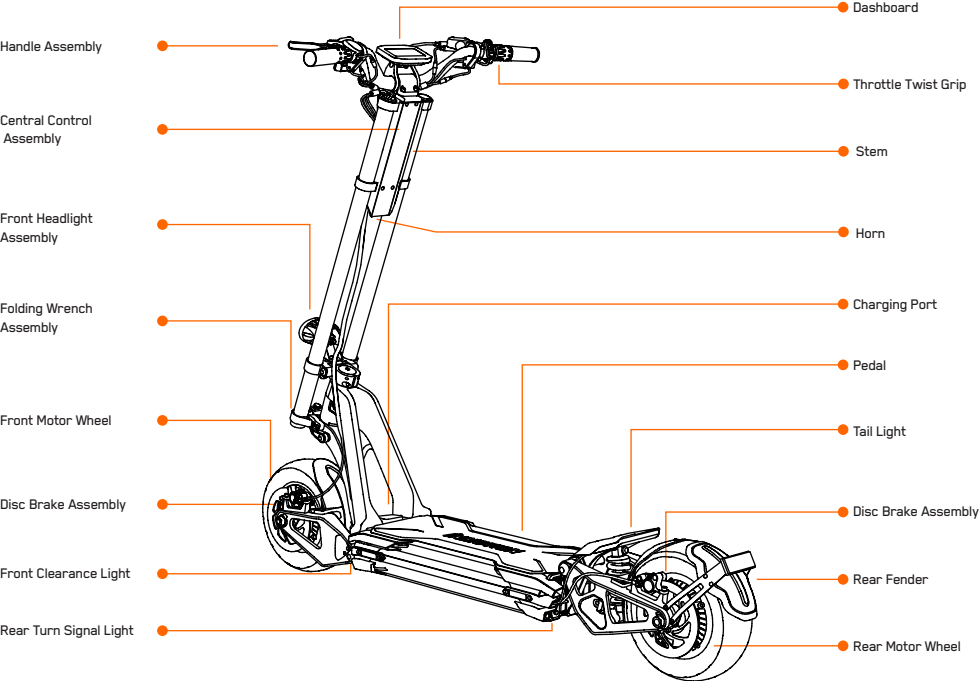



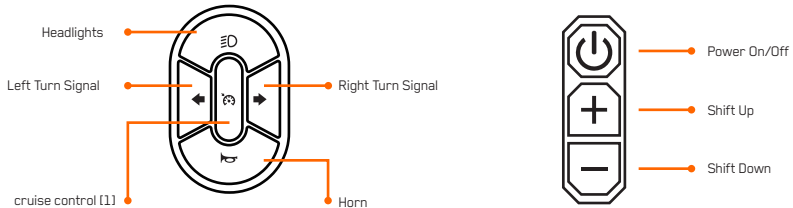
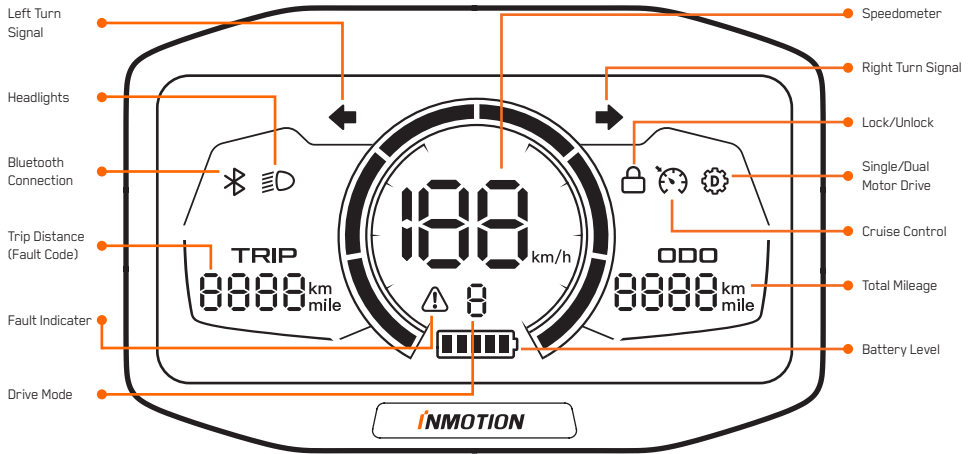











Dashboard and Buttons



[1]: Short Press: cruise control, long press: single/dual drive switching.

Product Function Introduction

Icon	Icon Name	Icon Description
	Power On/Off	Press and hold the power button to turn on/off the scooter. It will also automatically power off if there is no activity for 10 minutes, which can be adjusted through the App.
	Parking mode	0 represents the Parking mode. The scooter defaults to the Parking mode when it turns on. Press the + or - buttons to switch to the driving mode. You can also switch and adjust relevant parameters via the app.
	Drive mode	1-4 represents drive mode include four modes. 1 represents Eco mode with a speed limit of 32km/h. 2 represents Normal mode with a speed limit of 64km/h. 3 represents Sport mode with a speed limit of 100km/h. 4 represents Extreme mode, with no speed limit. The modes can be switched in order by pressing the + or - buttons. Note: The mode cannot be switched when pressing the throttle.
	Speedometer	Shows the speed of the scooter in real time.
	Speed unit	The Imperial System and the metric one, you can change the unit via the App.
	Light icon	Press the headlight button to toggle the headlights on or off.
	Bluetooth icon	The icon lights up after the bluetooth connection is successful.
	Cruise Control	While riding at a constant speed, press the button to activate or deactivate cruise control. Long press to switch single/dual drive mode.
	Locking	To use the locking feature, the owner of the scooter must first authenticate themselves through the App. Once connected, a lock icon will appear on the home screen. Click on the icon to lock or unlock the scooter. If the scooter is moved while locked, the lights and horn will cycle and then sound a single alarm after 3 seconds.
	Fault indicator	The icon indicates that the scooter has detected an error. Refer to the error code table to find solutions.
	Turn signal	Press the turn signal button, the turn signal on the corresponding side will flash for 5s.
	Battery level	The battery level is indicated by 5 bars, the last bar flashing indicates a low-battery level.
	Horn	Press the button while the scooter is powered on to honk the horn.
	Single/Double Drive Switching	Press and hold the cruise control button while the scooter is stationary to switch between single and double drive modes. The sequence of switching is Dual Drive -> Rear Drive -> Front Drive, and the driving mode icon will change accordingly.

ERROR CODE

Front/Rear Drive Controller Malfunction

Code	meaning	Explanation
101/201	Current sampling failure of drive controller	Controller malfunction, please reboot or contact after-sales service for replacement.
102/202	Hall fault of drive motor	Motor malfunction, please contact after-sales service for replacement.
109/209	Instrument did not receive data from the drive controller	Communication failure, the instrument did not receive the controller data.
110/210	Drive controller did not receive data from the instrument	Communication failure, the controller did not receive data from the instrument.
111/211	MOS over-temperature of drive controller	The temperature of the controller board is too high, please stop riding and wait for to cool down.
112/212	Overheating of drive motor	The motor temperature is too high, please stop riding and wait for the temperature to decrease.
114/214	Overheating of drive MCU	The MCU temperature is too high, please stop riding and wait for the temperature to decrease.
117/217	Overcurrent fault of drive controller	Controller malfunction, please reboot or contact after-sales service for replacement.
118/218	Stuck fault of drive controller	Motor stuck, please remove obstacles or contact after-sales service for replacement.

Notice:

- The first digit of a three-digit error code represents the faulty part, with 1 representing the front wheel and 2 representing the rear wheel

Other Faults

Code	meaning	Explanation
003	Battery communication failure	Battery malfunction, please contact after-sales service for replacement.
004	Undervoltage fault of the controller	The battery voltage is too low, please charge it in time.
005	Overvoltage fault of the controller	The battery voltage is too high, please stop using it and contact after-sales service.
006	Brake handle failure	When starting up, the brake handle is not released, please release the brake handle or check the brake handle.
007	Throttle handle failure	The throttle is detached or the throttle is not released when starting up, please release the throttle or check the throttle.
008	Battery error (undefined alarms, protections, and faults)	Battery malfunction, please contact after-sales service for replacement.
013	Battery over-temperature	The battery temperature is too high, please stop riding and wait for the temperature to decrease.
015	Attitude sensor initialization failure	Gyroscope initialization failure, please contact after-sales service.
016	Scooter fall warning	This error will be reported when the vehicle tilts over 45 degrees.

PRODUCT SPECIFICATIONS

Specifications	Item	Parameters
Basic Specifications	Model	RS
	Overall size of the Scooter	1453 * 716 * 1320mm (default)
	Net Weight	Approximately 58kg
Riding Requirements	Maximum Load Capacity	150kg
	Suitable Height	150-200cm
	Applicable Age	Ages 16-60
Main Scooter Parameters	Normal Riding Distance [1]	Approximately 120-160km [1]
	Max. Climbing Angle [2]	26°
	Max. Speed [3]	110km/h
	Waterproof Rating	IP56
	Charging Time	8.5 hours
	Temperature	-10° C - 40° C
	Storage Temperature	-10° C - 40° C
	Battery Pack Parameters	Intelligent BMS
Rated Voltage		84V
Rated Capacity		2880Wh
Motor Parameters	Rated Power	2000W*2
	Max. Power	4200W*2
Charger	Rated Input Voltage	AC100-240V 50/60HZ
	Rated Output Voltage (DC)	84V 5A
Others	Display	4.3-inch LCD screen
	Output Port	USB type-C
	Tire Size	11-inch vacuum tire (standard pressure: 40Psi or 2.8Bar)

[1]: Measured under the condition of full charge, 75kg load, ambient temperature of 25°C, and riding on flat, hardened road surface at a speed of 20–40km/h. The range is related to temperature, tire pressure, road conditions, riding habits (such as sudden acceleration, suspension), etc.

[2]: Measured with a load of 75kg and full battery.

[3]: Tested on a flat, hard surface with no wind and an ambient temperature of 25°C at full battery and carrying a load of 75kg.

Product Description

RS is a high-tech entertainment product. Riding it without understanding the operating procedures may cause unpredictable injuries and property damage. The following text will provide users with detailed instructions on how to properly use RS and precautions during use. Please read carefully and use RS as required. Before using RS, make sure that all parts are intact and installed correctly.



Warning:

- Before using the RS, please make sure that the battery is fully charged, preferably to 80% or more.
- You need to find a relatively open and flat outdoor area for driving practice. You need to have a good understanding of the driving environment around you to ensure that you will not be disturbed by obstacles such as cars, pedestrians, pets, bicycles, etc.
- Take the time to learn the basics of the practice to avoid any serious accident that can take place in the first months.
- You need a skilled assistant to guide you and be familiar with all the precautions and usage methods in this manual.
- Please do not test the scooter on wet or slippery ground.
- It is recommended that users wear comfortable casual or sports clothing, flat shoes, and warm up exercises to maintain flexibility.
- Please make sure to wear a helmet and riding protective gear to avoid injury.

ASSEMBLY

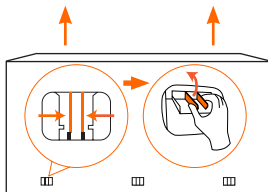

Open the package:

Take out the 6 connecting buckles and lift the outer box upwards, revealing the inner packaging and scooter, and take out the accessory box.

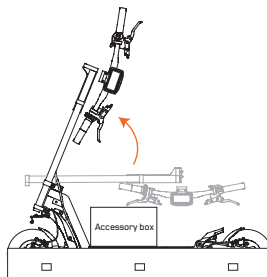

Hold the handlebars and unfold the folding stem:

Adjust the height of the stem according to the scale and lock the stem clamp.

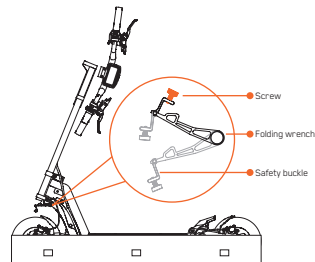

Fasten the folding wrench:

Fasten the folding wrench according to the diagram, turn the screw by hand to fix the safety buckle.

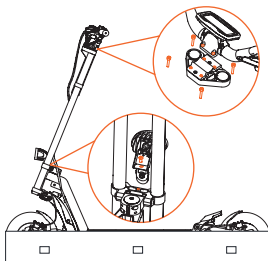

Install the handlebar and front headlight assembly:

Take out four M6*30 cylindrical head screws and one M8*16 hexagonal socket screw, tighten them in the corresponding positions according to the diagram.

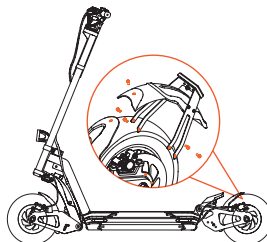

Install the rear mudguard:

Take out four M4*10 cylindrical head screws and one M4*8 round head hexagonal screw, tighten them in the corresponding positions according to the diagram.

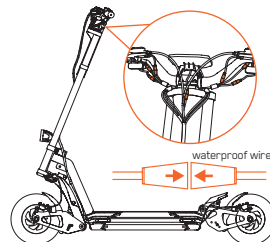



Connect the waterproof wire:

Connect the corresponding lines according to the color and follow the directional arrows. (Power switch key, dashboard, throttle, brake, turn signal, headlight waterproof wire)

ACTIVATE THE VEHICLE



Download the App via methods below

1. Scan the QR Code on the left.
2. Search "INMOTION" on  or .
3. Directly visit: www.inmotionworld.com/support/app

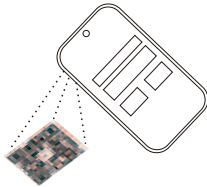

1. Download and install the App, register/login your account.

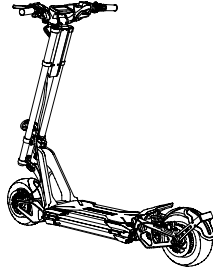

2. Power on the scooter, pair your scooter with the INMOTION App. The scooter will beep when the connection is successful.

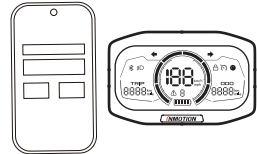

3. Follow the App instructions to activate the scooter and learn how to ride safely. You can now start to use your scooter.

Warning:

- There are safety risks when using a scooter. To ensure your riding safety, each scooter is shipped in an unactivated state, limited to ECO mode. You can activate your scooter by downloading the App to unlock full functionality.

ADJUST THE GEARS

For a better riding experience, there are four adjustable gears on the scooter, and the chassis height can be adjusted according to road conditions or personal habits. Instructions: Use two T-shaped hex wrenches to fix the screws at both ends of the connecting shaft. Rotate one screw counterclockwise to loosen it, remove the other screw from the connecting shaft, install the connecting shaft into the hole corresponding to the target gear according to your needs, and then tighten the previously loosened screw with the wrench.

Clockwise rotation of the screw increases the damping; Counterclockwise rotation reduces the damping.

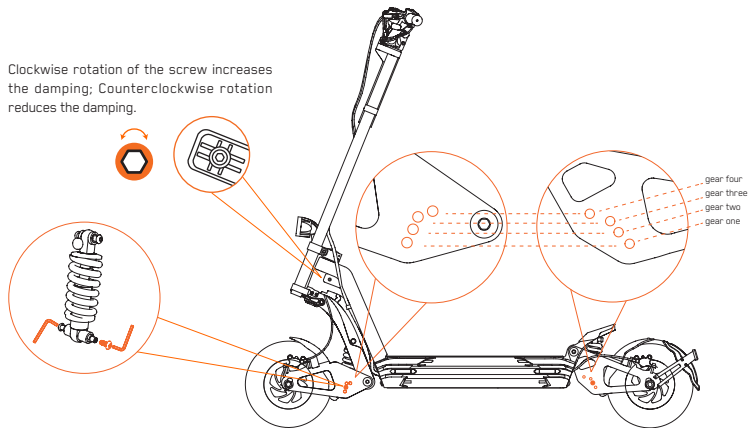

Scan the QR code to watch the video

Dimensions in folded/unfolded state

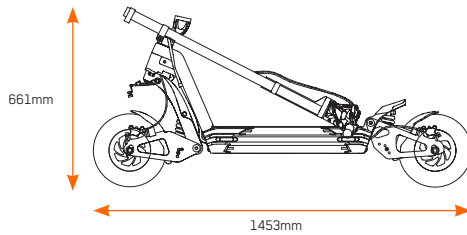
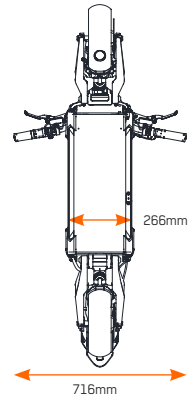
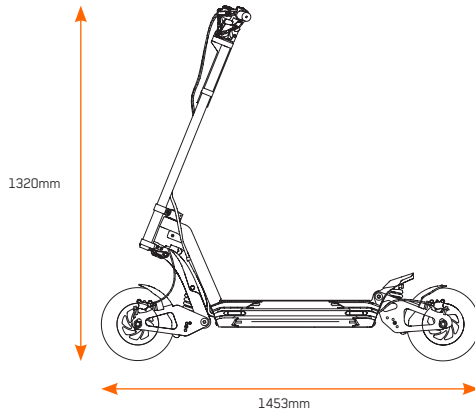

CHARGING

- The original charger is 84V 5A. The blue LED indicates power, the green LED indicates a full charge, and the red LED indicates that the scooter is currently charging. When two chargers are used simultaneously, the charging time will be reduced by 50%.

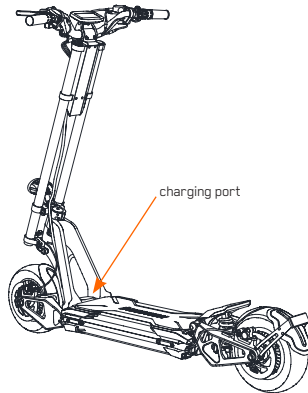

Warning:

- Do not charge if there is water at the charging port or power cord.
- Please use the original adapter for charging.
- Do not charge indoors.
- Cover the lid tightly after charging.
- Do not charge if the battery is damaged or has been exposed to water.
- If not in use for a long time, it is recommended to charge once every three months.

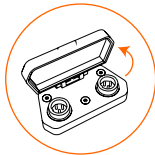

1. Open the charging port.

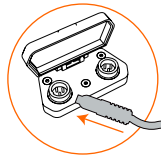

2. Insert the charger plug.

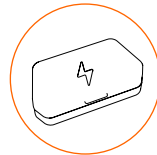

3. After charging is complete, unplug the charger plug and cover the charging port tightly.

INFLATING

For a better cycling experience, please be sure to check the tire pressure before each ride. If the tire pressure is low, please pump it up in a timely manner. The ideal tire pressure range is between 2.5 to 3.5 bar.

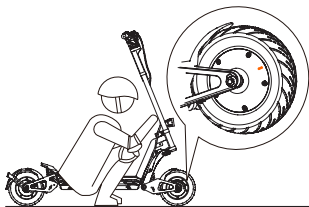

1. Unscrew the valve cap of the tire.

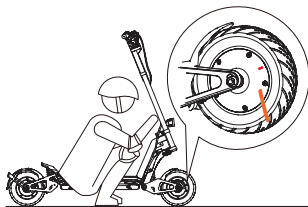

2. Screw the extension nozzle onto the valve and tighten it.

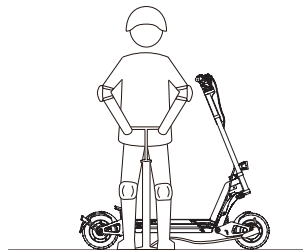

3. Connect the pump and inflate the tire to the recommended pressure.

Warning:

- The range and riding experience of the electric scooter are related to tire pressure. When the tire pressure is within the normal range, higher tire pressure will result in longer range; lower tire pressure will provide better shock absorption experience, especially on rough roads. Please choose the appropriate tire pressure according to specific usage scenarios.

LEARNING TO RIDE

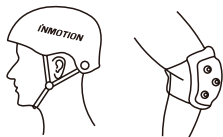

1. Wear Approved helmets, elbow pads, knee pads, and other protective gear to minimize any possible injuries.



2. Check the battery indicator light after turning on the power. If the battery level is low, please charge the electric scooter.



3. Stand with one foot on the pedal and push off with the other foot to start gliding.

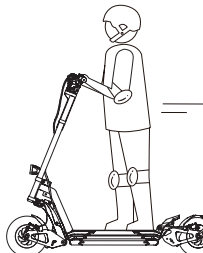

4. Stand with both feet on the pedals, twist the throttle handle to start riding.

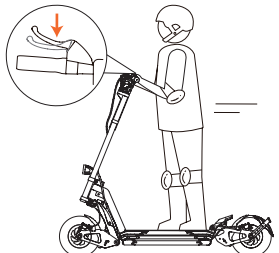

5. Release the throttle and gently grip the brake lever to brake.

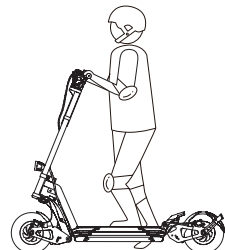



6. When the electric scooter stops or slows down, put one foot down to dismount.

SAFE DRIVING GUIDE

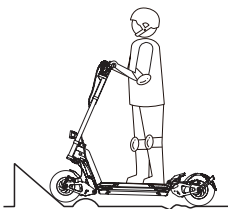

 Do not ride the scooter in the rain.



 Do not ride at high speed when you get over speedbumps, thresholds etc., please ride at low speed on rough roads.

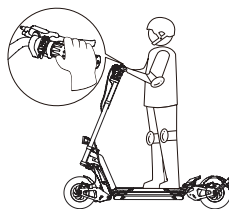

 Do not press the throttle when walking with the scooter.

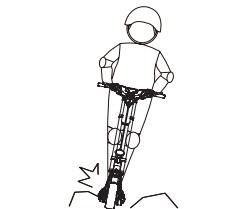

 Avoid contacting obstacles and watch out for the road conditions.

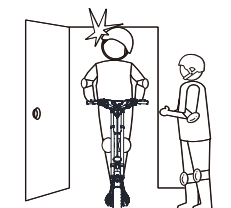

 Watch your head when passing through doorways.

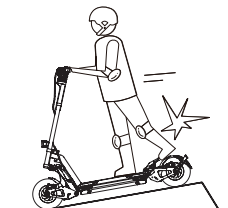

 Do not step on the rear fender.

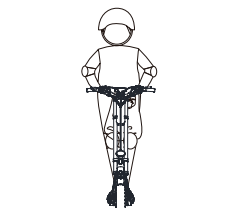

 Do not carry heavy objects on the handlebar.



 Do not ride the scooter with only one foot or one hand.

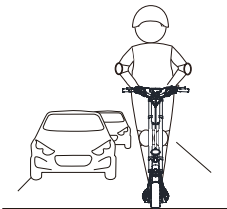

 Do not ride on motorways, public roads, or highways.

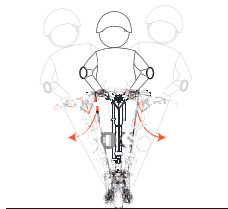

 Do not rotate the handle violently while driving at high speed.

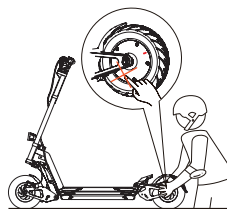

 Do not touch the motor, it may overheat after running.

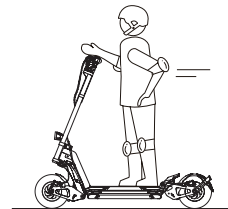

 Do not take your hands off the handlebar while riding.

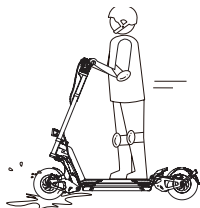

 Do not ride through puddles, please go around at low speed.

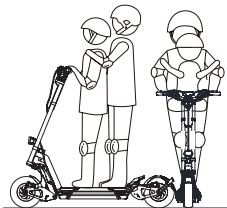

 Do not carry any passengers especially a child. Do not ride when pregnant.

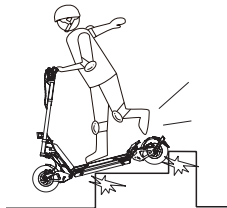

 Do not ride up and down stairs or jump over obstacles.



 Do not use mobile phone or wear earphones when riding the scooter.

SAFETY NOTICE

1. The scooter is a recreational product and is not considered a means of transportation. It is prohibited to ride on public roads designated for transportation. When riding, please abide by local laws, regulations, and policies.
2. Read this user manual carefully. If you cannot follow the instructions in this user manual completely, do not attempt to ride the scooter. In any case of riding, ensure that qualified helmets and other protective gear are worn.
3. Riding a scooter requires practice and mastery of corresponding riding skills. It is recommended to practice in a more enclosed and open road environment (such as internal communities, Parks, specialized venues, etc.). For the first ride, do not choose an area where children, pedestrians, pets, scooters, bicycles or other obstacles and potential dangers may Appear. If any damage is caused due to insufficient rider experience or failure to use this product according to this manual, Shenzhen INMOTION Technology Co., Ltd. will not assume any responsibility.
4. Following the tips and warnings in this manual can reduce risks but cannot eliminate all risks. Please remember that when using the scooter, there may be a risk of injury or death due to loss of control, collision, and falling. Do not exceed the speed limit. Do not ride on roads where motor scooters are present.
5. Before giving the scooter to someone else to use, make sure they have read this user manual and understand the risks of riding a scooter. You are responsible for ensuring the safety of new riders. Assist them in learning to use this product until they have mastered the basic operation of this scooter.
6. Do not place the scooter near an open flame or high temperature. Unauthorized modification and repair of the scooter are prohibited, otherwise, it may cause abnormal scooter performance and warranty invalidation.
7. If the scooter is damaged, emits an odor, smoke, overheats, or has parts with performance failures, stop using it immediately and contact after-sales service promptly.
8. **WARNING!** As with any mechanical component, a scooter is subject to high stresses and wear. The various materials and components may react differently to wear or fatigue. If the expected service life for a component has been exceeded, it may break suddenly, therefore risking causing injuries to the user. Cracks, scratches and discoloration in the areas subject to high stresses indicate that the component has exceeded its service life and should be replaced.
9. This product may contain detachable components. Keep it away from children to avoid harm caused by swallowing or accidental ingestion.
10. **WARNING!** Stop using the product when damaged.

RIDING INSTRUCTIONS

1. When riding this product, please abide by local laws, regulations and policies. It is forbidden to use in areas prohibited by local laws and regulations and relevant management units.
2. When riding, please respect the right of way of pedestrians. Pass on the left side of pedestrians whenever possible. When facing a pedestrian, stay to the right and reduce speed. Avoid frightening pedestrians, especially the elderly, children, disabled and pregnant women. When approaching a pedestrian from behind, alert the pedestrian and slow down when passing.
3. Notify your presence when Approaching a pedestrian or cyclist when you are not seen or heard.
4. Cross the protected passages while walking.
5. Traffic in the city has many obstacles to cross such as curbs or steps. It is recommended to avoid obstacle jumps. It is important to anticipate and adapt your trajectory and speed to those of a pedestrian before crossing these obstacles. It is also recommended to get out of the scooter when these obstacles become dangerous due to their shape, height or slippage.
6. Avoid high traffic areas or overcrowded areas.
7. In any case, anticipate your trajectory and your speed while respecting the code of the road, the code of the sidewalk and the most vulnerable.
8. Do not ride while fatigued. When riding, ensure that yourself and others are visible. Please pay attention to maintaining a safe distance from pedestrians or other scooters to avoid the risk of collision. Therefore, when approaching or passing through crowded pedestrian areas, intersections, or turns, please slow down, yield to pedestrians and other scooters.
9. Do not suddenly accelerate or decelerate. When riding, always grip the handlebars with both hands and stand on the pedals with both feet. Stunts are prohibited. Do not ride at speeds exceeding the maximum limit for scooters, as this may result in loss of control, collisions, and falls.
10. Do not make sudden sharp turns while traveling at high speeds or brake suddenly. These actions can easily lead to dangerous situations such as slipping and falling.
11. When riding a scooter, do not use headphones, earplugs, mobile phones, handheld recording devices, or engage in any activities or behaviors that may distract your attention, so that you can better monitor the external environment.
12. Do not ride in adverse weather conditions, low visibility, at night, or in the dark. Each of these situations increases the risk of accidents.
13. Do not ride a scooter in snowy, rainy, wet, muddy, or icy conditions for any reason. The resistance of the tires decreases on moist or slippery roads, increasing the braking distance and making it more likely to slip or lose control. When riding in rain or snow, the scooter may become soaked, resulting in function damage, fire, or even explosion due to damp batteries. Damage and losses caused by water ingress are not covered by the warranty.
14. When riding, please avoid obstacles, potentially dangerous road surfaces, and difficult-to-ride surfaces (including but not limited to wet and slippery surfaces, ice, swimming pools and other water areas, loose sand or material dispersed ground, steps and adjacent areas, and uneven terrain).
15. Any load on the handlebars will affect the stability of the scooter. Do not attach heavy objects.

Warning:

- **Riders are required to use this product for users aged 16-60 years old. Minors need to use it under adult supervision.**
- **Riders should wear safety gear such as helmets, knee pads, and elbow pads. Please use a qualified helmet and fasten the straps in the Appropriate position under the chin.**

- **People who should not ride this scooter include:**
- **People under the influence of alcohol or drugs;**
- **People who are unable to engage in strenuous physical activity due to illness;**
- **People with physical, sensory, or mental defects or lack experience and knowledge;**
- **People who cannot maintain balance;**
- **People whose weight exceeds the prescribed limit (see "Basic Parameters");**
- **Children under 16 years old;**
- **Pregnant women.**
- **The scooter is limited to single-person riding. It is prohibited for two or more people to ride at the same time, and it is forbidden to carry children or heavy objects.**
- **It is forbidden to wear high heels, slippers, or shoes that expose the toes. Tie up long hair to avoid accidents caused by obstruction of vision during normal riding.**
- **It is strongly recommended to wear protective goggles when riding to prevent dirt, dust, or insects in the air from injuring your eyes and causing accidents affecting normal riding.**

Riding Daily Inspection

1. Before riding, please carefully read this user manual.
2. Before riding, please ensure that you have sufficient physical and mental conditions to get on and off the scooter and control the scooter without assistance.
3. Before each ride, please check the scooter carefully to ensure that there are no loose parts, damage, component failures, low tire pressure or other abnormal conditions, and ensure that the brakes are working properly. If the scooter emits unusual odors, sounds, or alarms, please stop using it immediately and diagnose the issue using the INMOTION App, or contact official after-sales service or the aftersales service of the purchase channel to obtain professional technical guidance or maintenance services.
4. Before each ride, please check the battery level to ensure sufficient power to maintain your normal riding and avoid dangerous situations.
5. Do not touch the scooter brake system, as it may cause injury.
6. Please Park on a flat, sturdy surface. If Parking on a slope, the kickstand of the scooter must face downhill to prevent tipping over. Do not let the scooter's front end face downhill, as this may cause the kickstand to close under the force of gravity and the scooter to flip over. After lowering the kickstand, please check that the scooter is stable, to prevent it from overturning due to external disturbances such as sliding, wind, or shaking. Do not Park in busy areas. It is recommended to Park near a wall.
7. Parking while the scooter is still on may cause the body to move spontaneously, causing damage to you or the surrounding people or property. Please be sure to turn off the power before Parking.
8. Warning! Like any mechanical component, the scooter will experience high stress and wear.

Other

1. Only use original or Approved parts and accessories from INMOTION. Do not modify your scooter. Modifying your scooter may affect its operation, leading to serious damage and invalidating the warranty.
2. For a better riding experience, it is recommended that you regularly maintain the product (see "Maintenance Plan").
3. Children should not use scooters, play with scooter parts, or perform cleaning or maintenance activities.

MAINTENANCE

Cleaning

Use a soft damp cloth to wipe the scooter frame clean. If there are stubborn stains, Apply toothpaste and brush repeatedly with a toothbrush, then clean with a soft damp cloth.

Storage

When not in use, please Park the scooter indoors or inside a scooter to avoid damage caused by water ingress during rainy or snowy weather. The scooter should be stored in a cool, dry place. Do not leave the scooter outdoors for an extended period of time.



Warning:

- Before cleaning, make sure the scooter is turned off and the charger is unplugged and the charging port cover is securely fastened, otherwise it may damage the electronic components.
- Do not use alcohol, gasoline, kerosene or other corrosive, volatile solvents to clean your scooter. These substances may damage the Appearance and internal structure of the scooter. It is forbidden to use a pressure washer or hose for spraying and scrubbing.
- Sun exposure and extreme temperature conditions (overheating and freezing) will accelerate the aging of plastic parts and may reduce battery life.

Battery Maintenance



Warning:

- Please use the original charger and battery pack. Do not use other models or brands of chargers and battery packs, as this may pose a safety risk.
- Do not exceed the specified temperature limit when storing or charging the battery (see "Specifications").
- Do not touch the battery contacts, do not open or pierce the casing. Avoid metal objects from coming into contact with the battery contacts to prevent short circuits, which may cause damage to the battery or injury to personnel.
- Do not throw the battery pack into a fire, as this may cause the battery to fail, overheat, or even catch fire.
- Please keep it out of reach of children and animals, and keep it away from flammable materials during charging.
- Do not charge the scooter in a damp environment.
- If the battery is damaged or water enters it, do not charge it or continue to use it.
- Do not remove the battery. Disassembling the battery is complicated and may affect the operation of the scooter.
- Do not attempt to disassemble the battery, as there is a risk of fire. Users cannot repair the parts contained in this product by themselves.

- Do not ride this scooter in an environment where the ambient temperature exceeds the operating temperature of the product (see "Specifications"), as both low/high temperatures will limit the maximum power output and may cause slipping or falling, resulting in personal injury or property damage.
- After each use, charge the battery to 60%-80% for storage, which helps to extend the life of the battery. Fully depleting the battery may cause permanent damage, so please avoid completely depleting the battery.
- Improper disposal of used batteries may seriously pollute the environment. Please comply with local regulations when disposing of used battery packs. Do not dispose of used battery packs at will, and let's protect the natural environment together."

Notice:

- The electric scooter will continue to consume power even when it is turned off. If the scooter is not used for a long time, the battery needs to be stored with at least 60% of its power, and it is recommended to charge the battery every 30-60 days. Otherwise, the battery may be over-discharged, which can damage its performance. There is an intelligent chip inside the battery that records its charging and discharging status. Damage caused by overcharging or over-discharging is not covered by the warranty.
- Maintaining a well-functioning battery pack can ensure good operating condition even after traveling long distances. The battery's best range and performance can be achieved when used at room temperature (25°C). However, when used below 0°C, the battery's range and performance may decrease. Generally speaking, low temperatures can affect the product's range, and the lower the temperature, the shorter the range.

TRADEMARK AND LEGAL STATEMENT

Personal Information Statement

1. Your personal information refers to all the information voluntarily entered by you when registering and authenticating with the INMOTION App and connecting with the unicycle.
2. During the use of the App, the personal information you provide in car owner authentication, product serial number activation, surveys, after-sales tracking and follow-up, and activity participation related to the product or service is for us to provide you with better products and services, and to improve and enhance your user experience.
3. You have the right not to provide personal information, but if you do not provide certain personal information, we may not be able to provide you with better products and services, and it may even affect your use of our products.
4. If you provide any personal information, it is deemed that you fully agree that INMOTION can use and disclose it to affiliated companies. The use of INMOTION and affiliated companies includes but is not limited to internal employees, consultants, agents, suppliers, and partners.
5. You agree that we may provide your personal information to relevant third parties under any of the following conditions:
 6. With your special authorization;
 7. In compliance with relevant laws or mandatory requirements proposed by government agencies (including judicial authorities);
 8. To enforce available service terms (including investigating possible violations);
 9. To deal with fraud, security or technical issues;
 10. To protect the rights, property or safety of users or the public from harm within the scope required or permitted by law;
 11. In special and/or urgent circumstances.
 12. The use, transmission, and storage of your personal information includes electronic data methods, and the above actions may be located inside or outside China.
13. For your better use and experience, you fully agree that INMOTION and affiliated companies may push information about products, services, and related activities to you irregularly.
14. To protect the security of your personal information, we will adopt reasonable and secure measures to protect your personal information from unauthorized disclosure and use, and we will also urge other relevant parties who accept and use your personal information to fulfill the same obligations as stated in this legal statement. You agree that INMOTION will determine the storage and retention time of your personal information according to the required time for the purpose of use or any agreement, laws, and regulations.
15. You agree to fully exempt INMOTION and/or receiving parties and/or using parties from all claims, responsibilities, and losses caused by or may be caused by disclosing and using your personal information in accordance with this legal statement, unless the aforementioned claims, responsibilities, and losses are directly caused by the receiving party and/or using party's intentional act or gross negligence.

Trademark Statement

1. INMOTION is a registered trademark of Shenzhen INMOTION Technologies Co., Ltd.; Android is a trademark of Google Inc.; App Store is a service mark of Apple Inc.; other trademarks mentioned in this document belong to their respective owners.
2. This manual has included as much feature description and usage instructions as possible in printing. However, due to product function constantly improving, design

changes, etc., there may still be discrepancies with the product you purchased. Due to product updates, there may be some deviations between this manual and the actual product in color, Appearance, and other aspects. Please refer to the actual product. Shenzhen INMOTION Technologies Co., Ltd. is not responsible for any claims, liabilities, and losses caused by or may be caused by consumers or any third party violating this legal statement.

3. Shenzhen INMOTION Technologies Co., Ltd. reserves all rights.
4. Manufacturer: Shenzhen INMOTION Technologies Co., Ltd.
5. Address: 18/F, Building B1, Nanshan iPark, No. 1001 Xueyuan Avenue, Nanshan District, Shenzhen, Guangdong Province.

Intellectual Property

1. Unless otherwise provided by laws and regulations or agreed upon in a separate agreement, INMOTION reserves all rights to the intellectual property (including but not limited to copyright, trademark right, patent right and its Application right, implementation right, permission right and other powers) of the product, its attachments, App and website. Without INMOTION's prior written consent, no one shall illegally use or dispose of it in any other way.
2. This legal statement applies to the laws of the People's Republic of China.
3. INMOTION shall not be liable for any claims, liabilities, or losses incurred or possibly incurred by consumers or any third party who violates this legal statement.
4. This legal statement constitutes an inseparable legal part of INMOTION's products (please also forward it when reselling the product).
5. You can choose to fully accept all the terms of this legal statement to use INMOTION's products. If you use INMOTION's products, it is deemed that you agree to accept all the terms of this legal statement and bear any possible risks and responsibilities.
6. If you do not agree to accept all the terms of this legal statement after purchasing our products, please return them and ensure that the returned products and packaging are intact and will not affect secondary sales.
7. Thank you for choosing and trusting INMOTION. If you have any questions, we are always happy to serve you!

Contact Us

If you have any issues related to riding, maintenance, and safety, or if your scooter has an error/fault, please contact us.

Shenzhen INMOTION Technologies Co., Ltd.

Address: 18th floor, B1, Nanshan iPark, No.1001 Xueyuan Avenue, Nanshan District, Shenzhen, China.

Telephone: 4000100012 extension 8015.

Email Service: service@imscv.com.

Email for Amazon US Services: AmazonService@imscv.com.

Website: www.inmotionworld.com.

INMOTION App: Me → Online Service.

Notice:

- When contacting INMOTION, please provide the serial number of the corresponding vehicle. You can find the serial number of your vehicle on the vehicle nameplate or under "About Vehicle" in the App's "Vehicle Management".



INMOTION App



Facebook group



Website